



8 0 'U '8



INSTALLATION GUIDE

SKU - SL-MODELG6-L
REV: 2.0_09/2024

Contents

@	11
u	11
h	\o".....	11
)	11
7	11
V	11
@	11
7	" @.....	11
@	11
.	11
o	11
y	11
y	".....	11
y	11
U	11
8	11
@	11
-	11
8	11
‡ °kk° Vu	11
#	11
-	20
#	'h.....	20
o	1

1. Installation requirements

The base or foundation for Sauna must be **leveled** and **stable**. Sauna must be at least 3 inches higher from the surrounding ground. All base beams must have a support under them. Weight of the sauna: 2645 lbs.

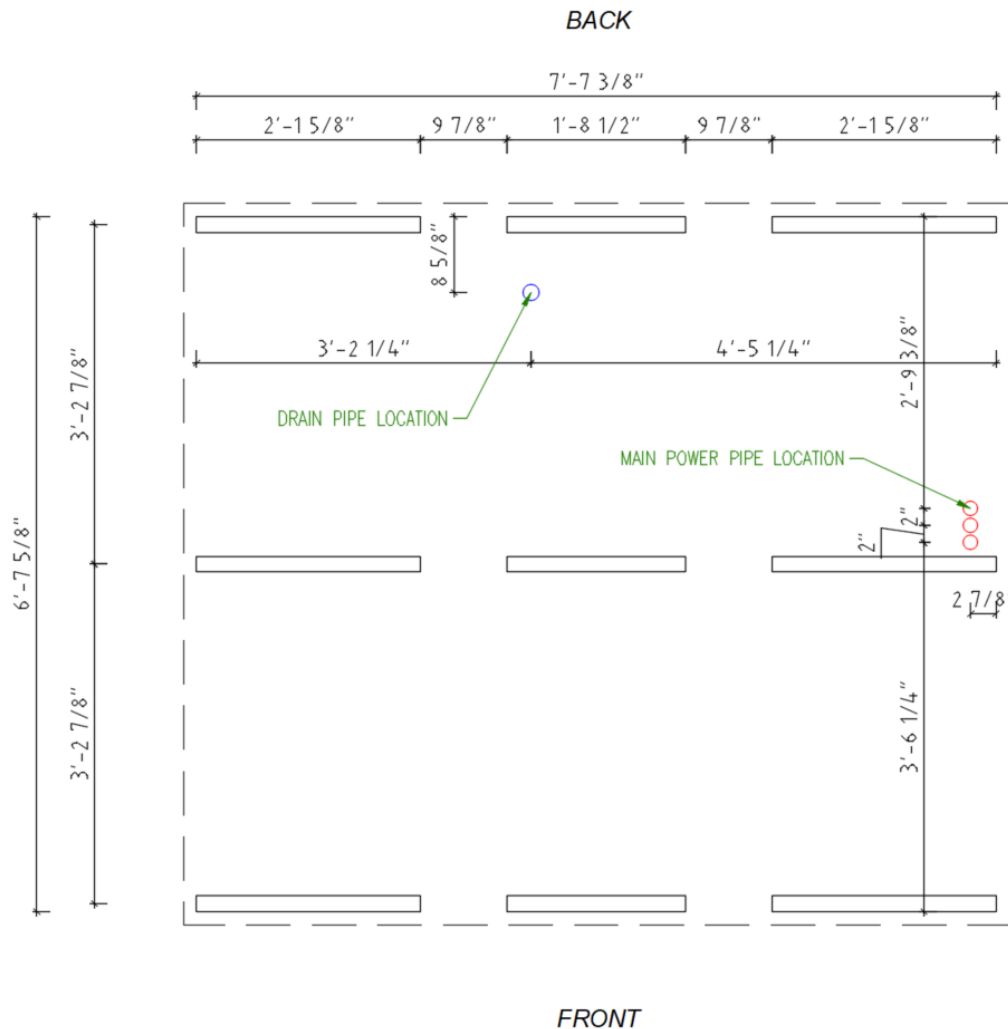

Recommendation:

We recommend placing Sauna on concrete blocks or strips that have a compressed gravel underneath. Using geotextile under the Sauna prevents the growth of grass and weed.

It is also possible to place the Sauna on terrace or pavement, but the Sauna should still be higher than the surface.

2. Transport

Sauna is packed into protective OSB box. Do not disassemble the OSB box until after lifting the sauna into its final location. Total weight of the sauna with OSB box is 2976 lbs.

Sauna can be lifted from **above with crane**:

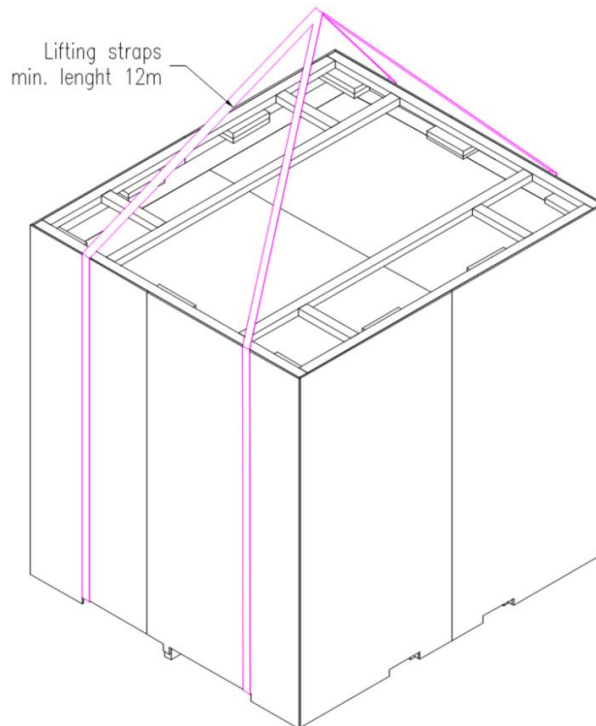

Sauna can be lifted from **below with forklift**:

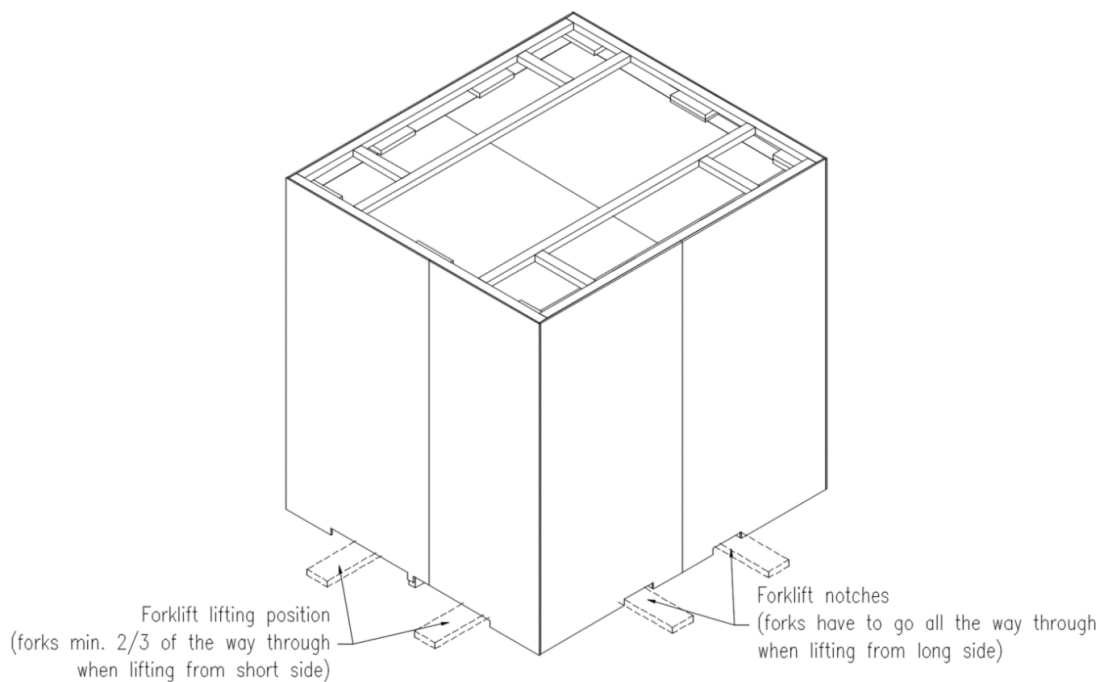

3. Protective OSB box disassembling

Dismantle the protective OSB box before final assembly. OSB boards are fastened with small screws covered with round stickers. The OSB boards, including the screw cover stickers, are painted black. The stickers prevent paint from getting into the screw heads and the screws are much easier to find.

Disassembling steps:

1. Remove stickers from the boards
2. Unscrew the boards with a power screwdriver
3. Remove the OSB boards and stack them on a level surface
4. Make sure that the supports of the boards do not come loose and fall down when loosening the screws

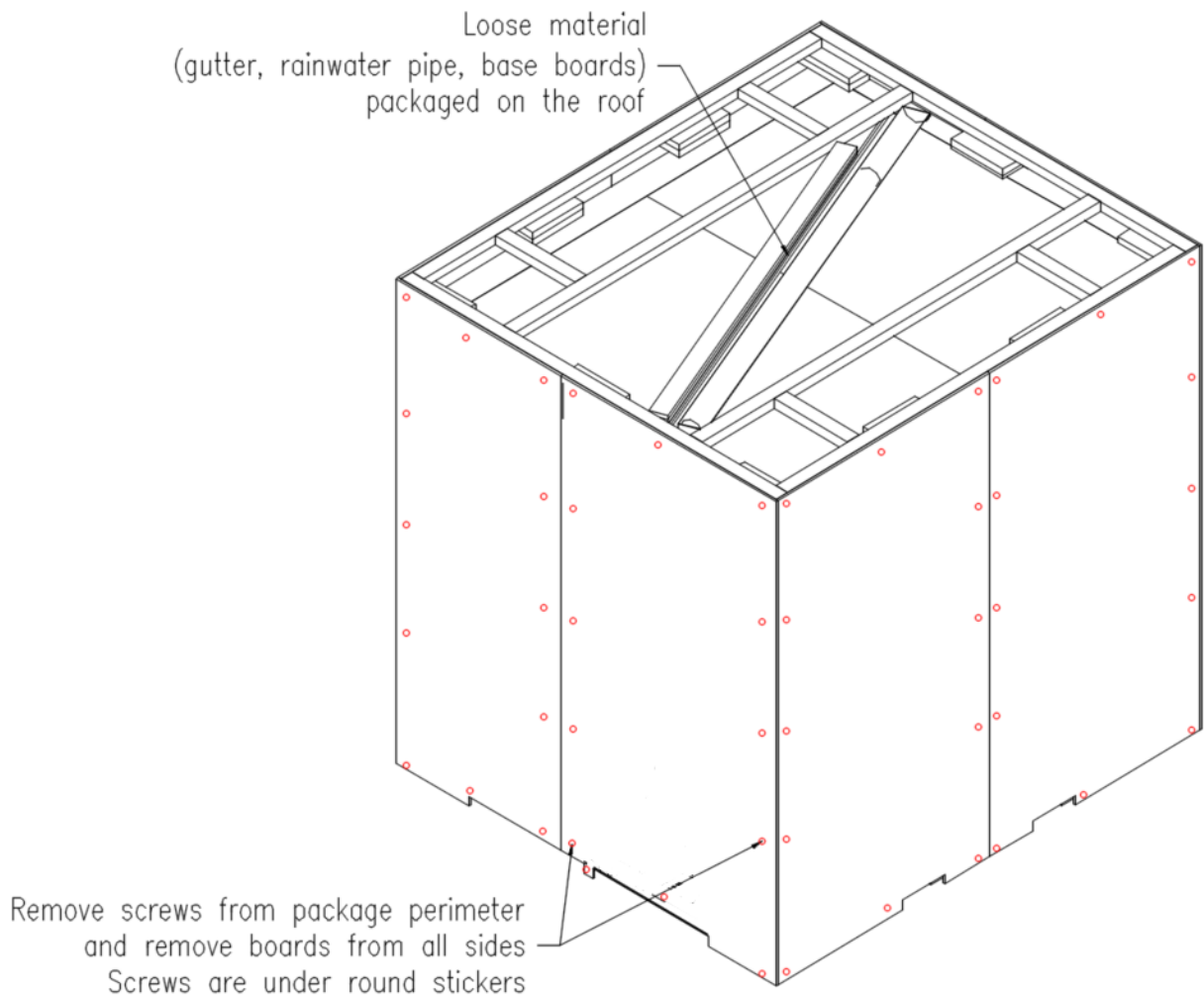

5. Once all the boards around the sauna have been removed, you can start dismantling the board supports at the top and bottom of the sauna
6. The sauna has a wooden frame at the top that is not attached to the sauna itself.
7. The lower part of the boards is supported with timber. These are fastened with longer screws
8. Board supports and roof frame taken off; the final assembly process can be started.

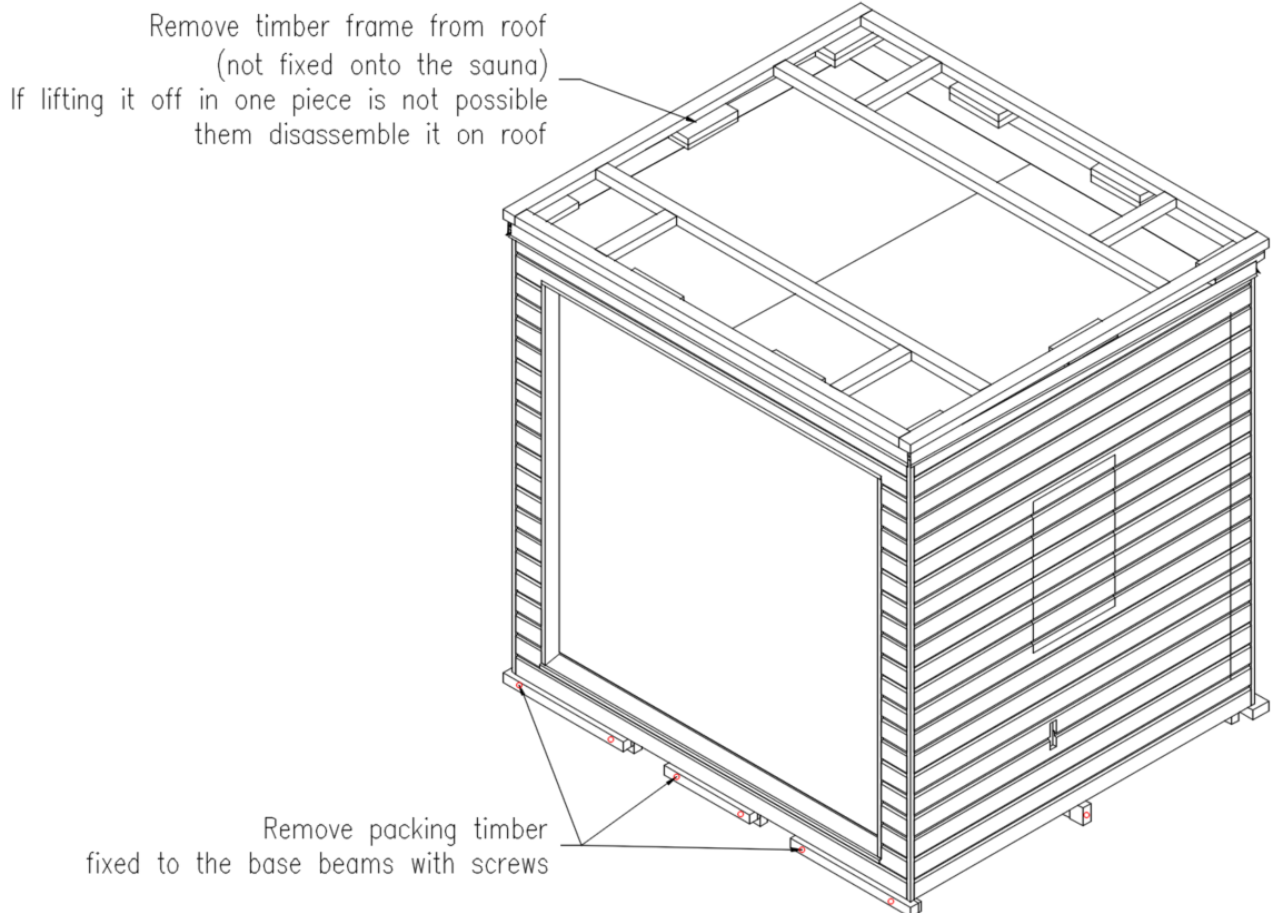

PS!

1. Be aware of the risk of falling objects when unpacking the package
2. Screw markings on drawings are indicative
3. Dispose of packaging material according to local requirements

4. Final assembly

Final assembly shall be organized **by the client**. All electrical connections must be made by certified electrician.

Final assembly includes installing of the:

- Parapet metal;
- Decorative base boards;
- Rainwater system;
- Main power cable;
- Heater (*+ control unit*);
- Outdoor 12V lights.

Sauna door must be adjusted according to the instructions after the final installation, if needed.

Needed tools for the assembly

- Ladder
- Level
- Tape measure
- Drill Driver
- TORX head driver bit set
- 8 mm hex head socket for the driver
- Sheet metal scissors
- Metal cutting saw
- 1/8-inch drill bit for metal
- Rivet gun
- Pliers
- Hex key set
- Screwdriver set
- Sealant gun + weather resistant silicone
- Paint brush
- Circular saw

Included assembly materials

Fixings:

4x50; TX20 woodscrews, black

5x70; TX25 woodscrews

3,2x8 rivet, black, alu.

Exterior finish:

Extra cladding boards, 2 pcs.

Base boards, 4 pcs. (top of the roof)

Repair paint, 400 ml

Rainwater system:

Gutter (top of the roof)

Gutter support bracket, 4 pcs.

Drop outlet

Downpipe (top of the roof)

Downpipe brackets, 2 pcs.

Outlet

Final Assembly Instructions

Base boards installation

Purpose of the base boards is decorative. Baseboards have been cut in the correct length and have pre-drilled holes in them. When installing the baseboards, make sure you are using the right board on the correct side. Attach each baseboard to the base beams using 4x50mm (black) woodscrews.

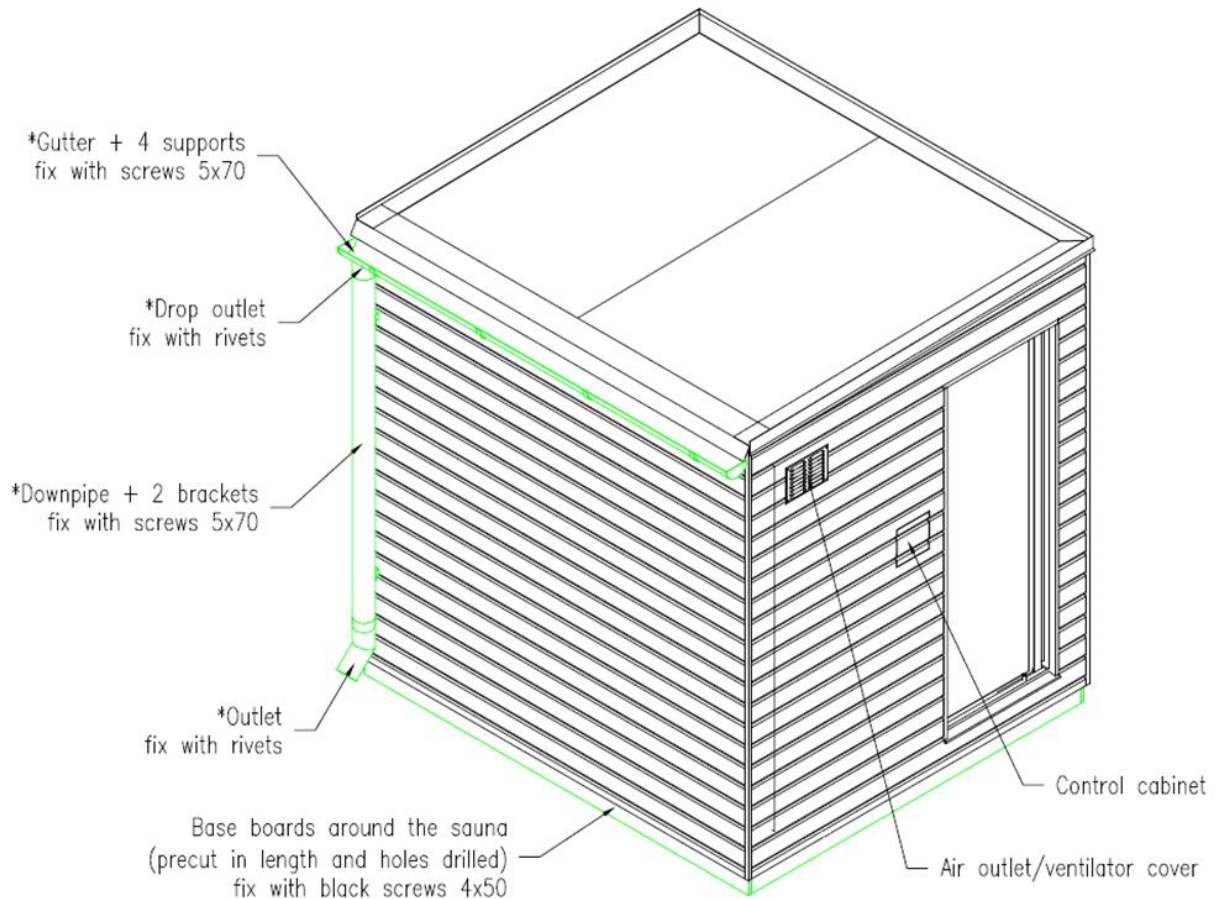

Interior floor grid adjustment

To adjust the floor grid for heater installation, make sure the heater rests directly on the ground and not on the grids. You can achieve this by either cutting a hole in the grids that matches the heater's size or by rotating the grids 90 degrees to allow for a proper fit and maintain effective airflow around the heater

Rainwater system installation

1. Begin the assembly process by securing gutter brackets to the wall using 5x70 woodscrews, with 2 screws per bracket. Distribute the gaps equally between the five brackets along the length of the gutter.

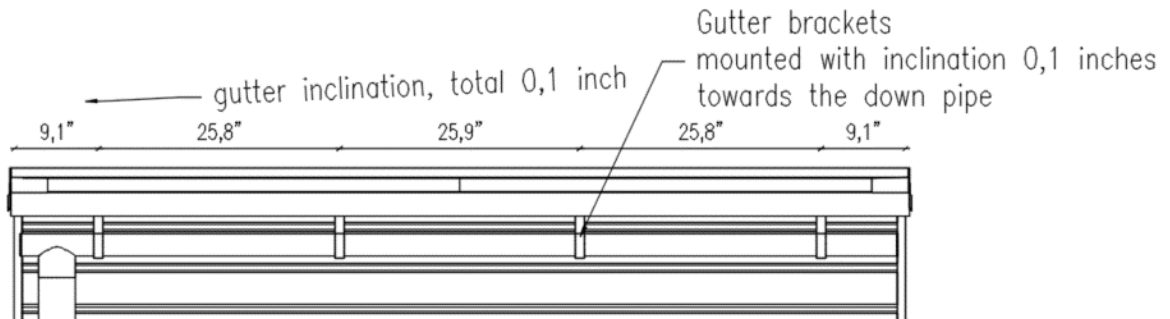

2. The brackets should be mounted with a slight downward angle towards the drain outlet
3. Mark the location on the underside of the gutter where you want to attach the downpipe. Using a hacksaw, make an opening in the base of the gutter



4. Position the gutter on the brackets and push it down until it clicks into place.
5. Place the drop outlet from below over the hole cut in the gutter. Bend the strips of the outlet around the edges of the gutter so the end piece is firmly in place. Use Pliers if necessary

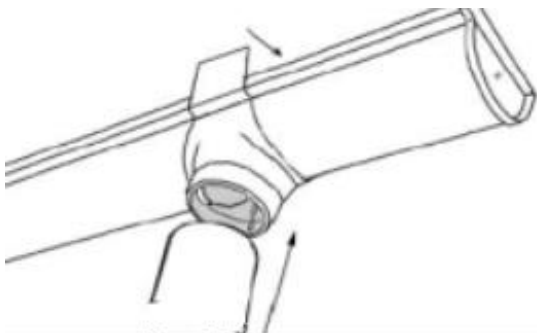

6. Install downpipe brackets use 5x70 screws two or each on the centerline of the drop outlet. Use 5x70 screws two or each. Brackets are required on both ends of the downpipe - at the connection with the drop outlet and at the elbow outlet.

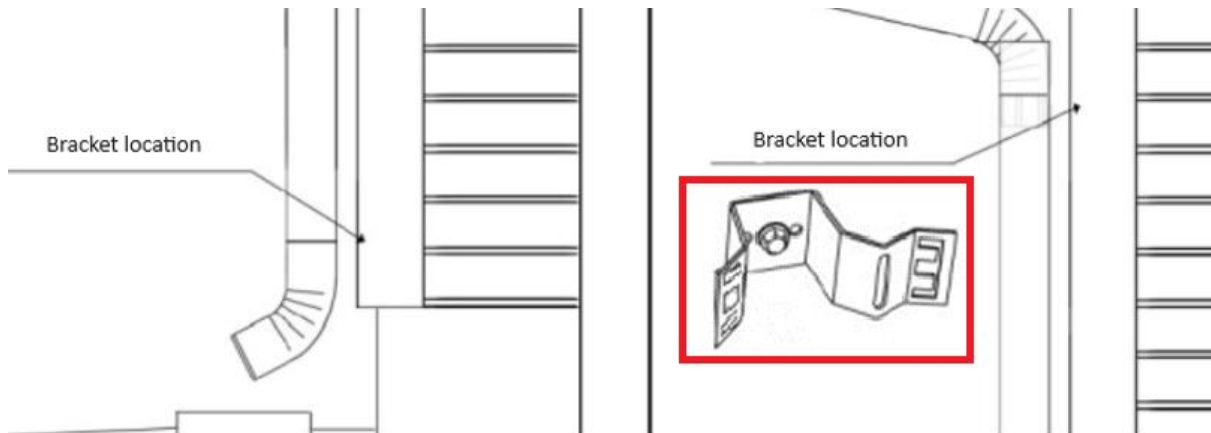

7. Insert the downpipe into drop outlet and fasten the pipe on the wall with brackets.

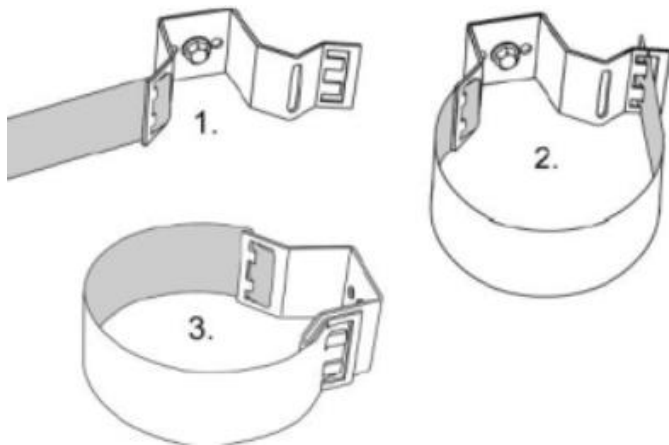

8. Finally use rivets to attach the pipe ends to the outlets.

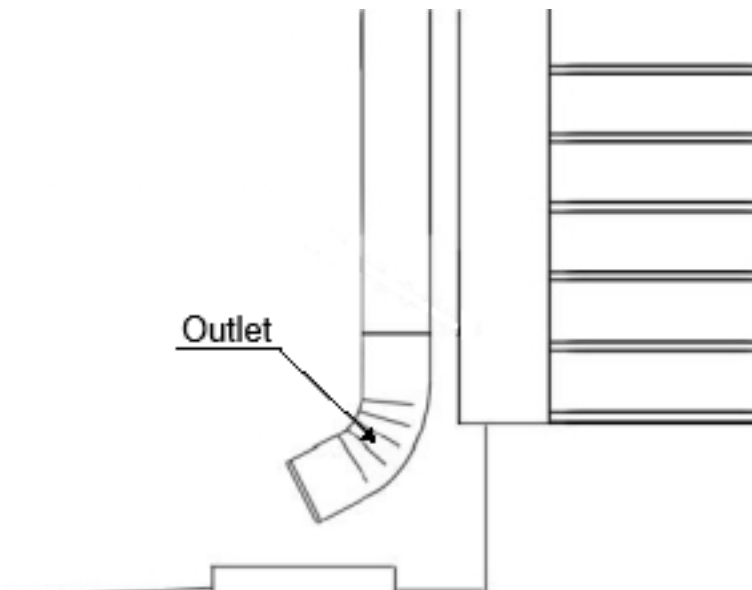

5. Instructions for adjusting sauna door

Adjusting the hinge

1. Remove covers from the hinges from the inside of the sauna to reveal the bolts
2. Unscrew the bolts a bit on both hinges to loosen the door leaf



3. Adjust the door leaf position inside the frame.
4. If gaps between door glass and frame are equal and parallel then tighten the bolts



Place back the hinge cover.

6. Sauna electrical connections

Saunas have been prewired. All electrical connections for LED lights, speakers and ventilator are made in factory (**Figure 1**).

All the electrical connections must be made by certified electrician.

Electrical connections

1. There are two electrical boxes (120 VAC and 240 VAC) located behind wooden door on the side of the sauna. Door can be unlocked with the small key, that is provided with the sauna
2. The top electrical panel 120 VAC is for LED lights and lower one 240 VAC for heater control unit + ventilator. The access doors to the electrical boxes can be opened using a flat head screwdriver.
3. To get to the electrical connections, you need to unscrew the metal covers using a TX20 screwdriver.
4. After you have removed metal covers, you will find distribution terminal blocks, where power supply cables must be connected (**Figure 1, Nr.8**) Powering lights/vent 120V max. 1kW/9A, wires three 16AWG, 600V and for powering heater 240V max. 11kW/46A, four wires 10AWG, 600V. All cables must be external use only.
5. Underneath the sauna, there are three conduit pipes, which are intended to run through power cables for sauna.
6. Cables will enter 240 VAC box through holes in bottom of electrical cabinet (**Figure 2, POWER**). Cabel in 120 VAC box will enter through the side of the cabinet (**Figure 2, POWER**).
7. Wires must be connected to distribution terminal blocks and tightened with the screws. (**Figure 2, Nr.8**)

240 VAC box:	120 VAC box:
<ul style="list-style-type: none">• L1 – 120 VAC live wire• L2 – 120 VAC live wire• N – neutral wire• PE – ground wire	<ul style="list-style-type: none">• L1 – 120 VAC live wire• N – neutral wire• PE – ground wire
8. 240 VAC electrical cabinet has free space for mounting heater control unit box (**Figure 2, Heater Control Box**). All cables, that need to be connected to control unit are labeled (Heater power, Heater vent, Temp. sensor, Controller, Door sensor). Heater manufacture installation manuals must be followed.
9. Preparations have been made for controller installation inside or outside the sauna. String has been threaded through conduit leading to a 120VAC electrical box (**Figure 2, Controller & Controller box**). There are two options for installing heater control unit. 9.1. Inside the sauna and 9.2. Outside the sauna, into the control cabinet.
 - 9.1 In sauna control unit - Before installing the controller inside the sauna, ensure it meets the steam room installation requirements. A cavity wall box is located behind the wall panels and connected to the 120VAC electrical box via conduit.

Drill a 2.5-inch hole through the wall panel as indicated in **Figure 4**. Inside the cavity box, the string leading to the electrical box should be used to pull the controller cable through conduit after tying them together. Always follow the manufacturer's installation manual to select the appropriate cable for the installation.

9.2 Out sauna control unit – The sauna features a controller box located outside the sauna. Behind controller box is conduit which is connected with 120 VAC electrical box. For installation, drill a 2.5-inch hole in the back wall of the controller box, as shown in **Figure 3**. Then, run the controller cable through the conduit into the electrical box, making sure to follow the manufacturer's. Door sensor cable (2x0,75) is preplaced trough door threshold. While mounting heater, the door sensor must be installed. Door sensor must be flush with the door threshold and the magnet need to be glued underneath the door frame.

10. Inside the wall is rigid pipe, which leads to the 120 VAC electrical box. To install temperature sensor, hole needs to be drilled through heater side of the wall. Drilled hole must be at least 2 inches deep, but not more than 3 inches. Location of the hole is shown on **Figure 5**. Measurement must be taken from the window frame and the ceiling. After the hole is drilled, suitable cable must be pulled through hole and pipe. Follow heater manufacture installation manuals.

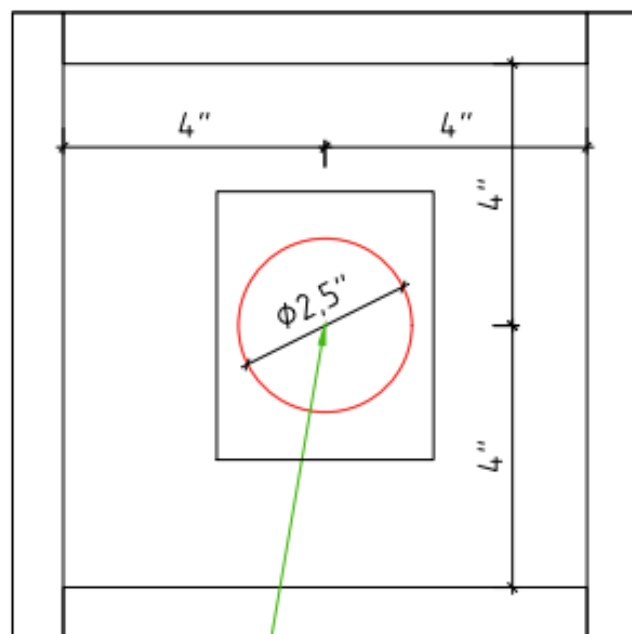

Drill hole to access
the conduit pipe behind the box
and run wires for controller

Figure 3.

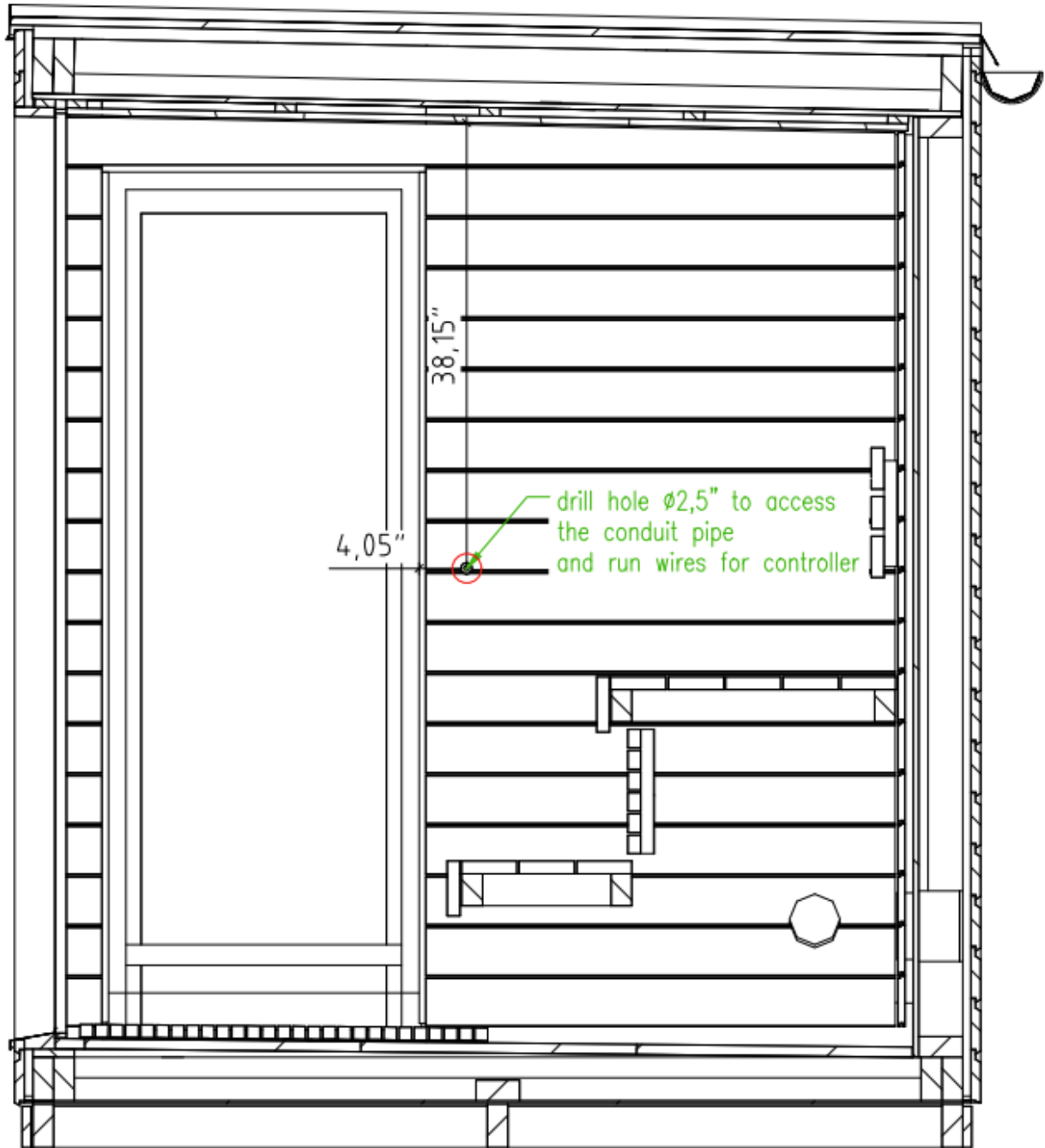

Figure 4.

Pipe location in the wall for temperature sensor
height 2-13 inches from ceiling
Client can drill the hole in the appropriate height
and rurd the wire through

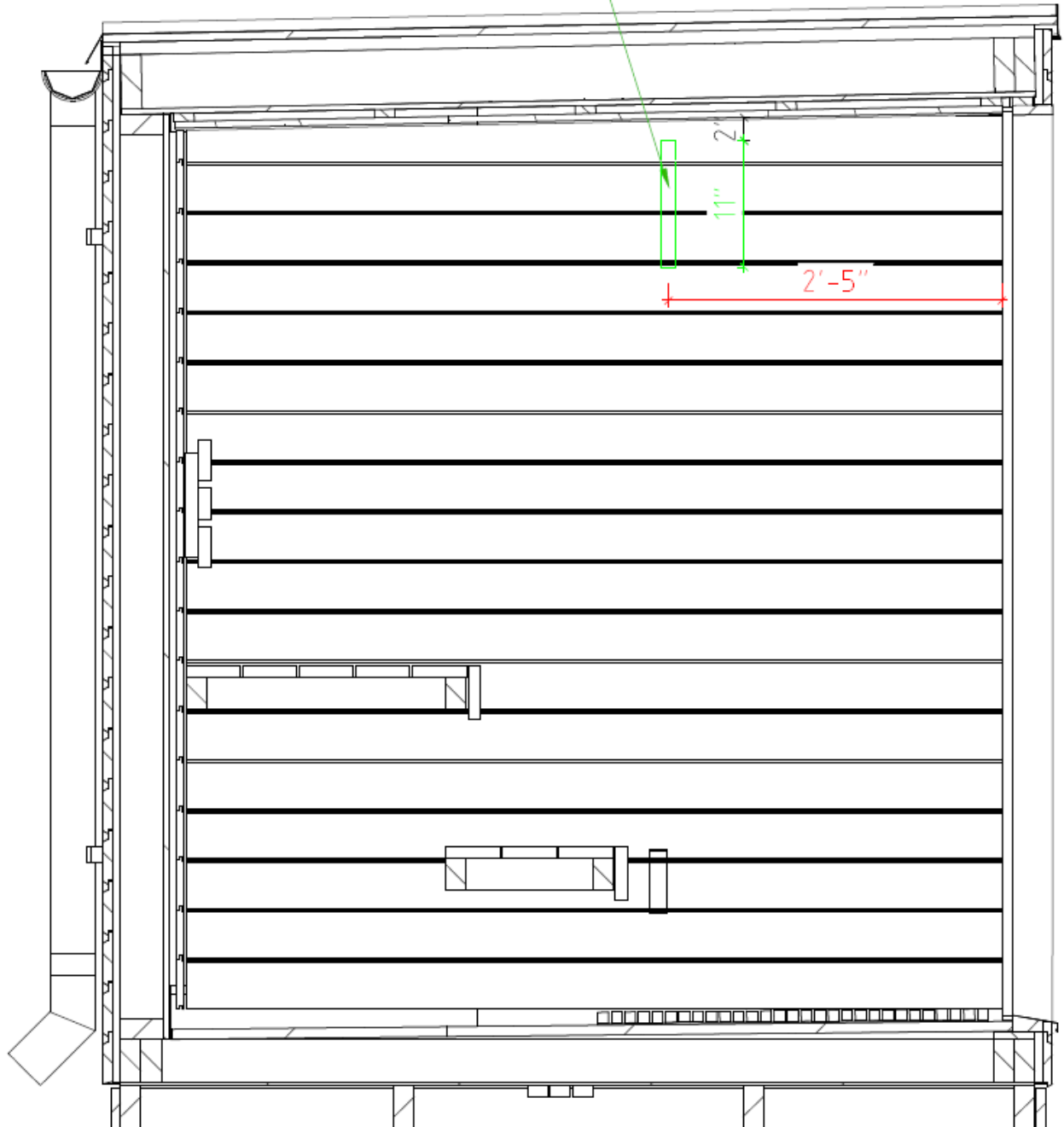
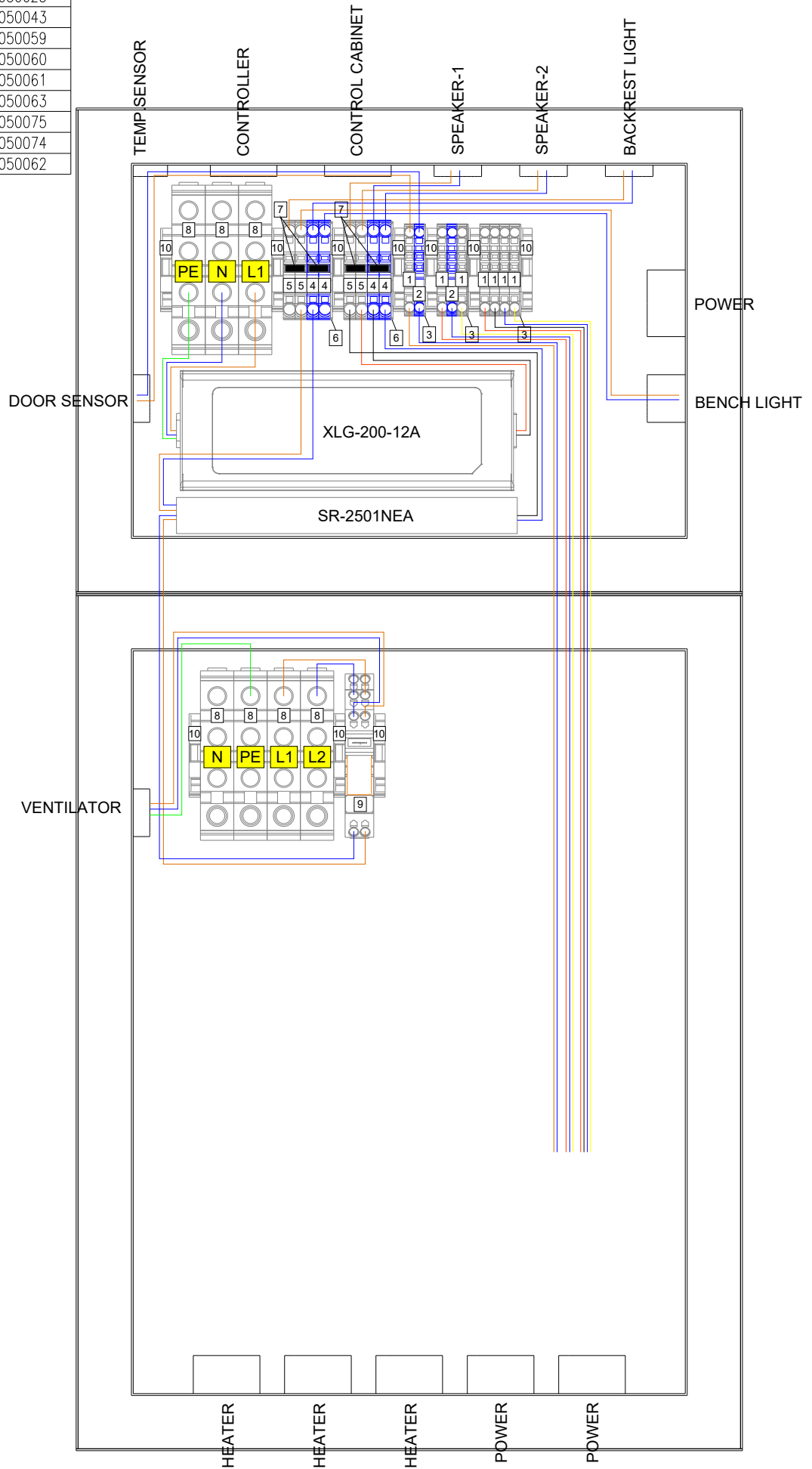

Figure 5.

PART SPECIFICATION		
NUMBER	MANUFACTURER CODE	ORDER NR
1	WAGO 2002-1201	9050023
2	WAGO 2002-1204	9050025
3	WAGO 2002-1291	9050043
4	WAGO 2004-1201	9050059
5	WAGO 2004-1204	9050060
6	WAGO 2004-1291	9050061
7	WAGO 2004-402	9050063
8	WAGO 284-621	9050075
9	WAGO 788-311	9050074
10	WAGO 249-116	9050062

Figure 1.
SAUNALIFE G6
CONNECTIONS DONE IN FACTORY



PART SPECIFICATION		
NUMBER	MANUFACTURER CODE	ORDER NR
1	WAGO 2002-1201	9050023
2	WAGO 2002-1204	9050025
3	WAGO 2002-1291	9050043
4	WAGO 2004-1201	9050059
5	WAGO 2004-1204	9050060
6	WAGO 2004-1291	9050061
7	WAGO 2004-402	9050063
8	WAGO 284-621	9050075
9	WAGO 788-311	9050074
10	WAGO 249-116	9050062

Figure 2.
SAUNALIFE G6
CONNECTIONS AFTER SAUNA INSTALLATION

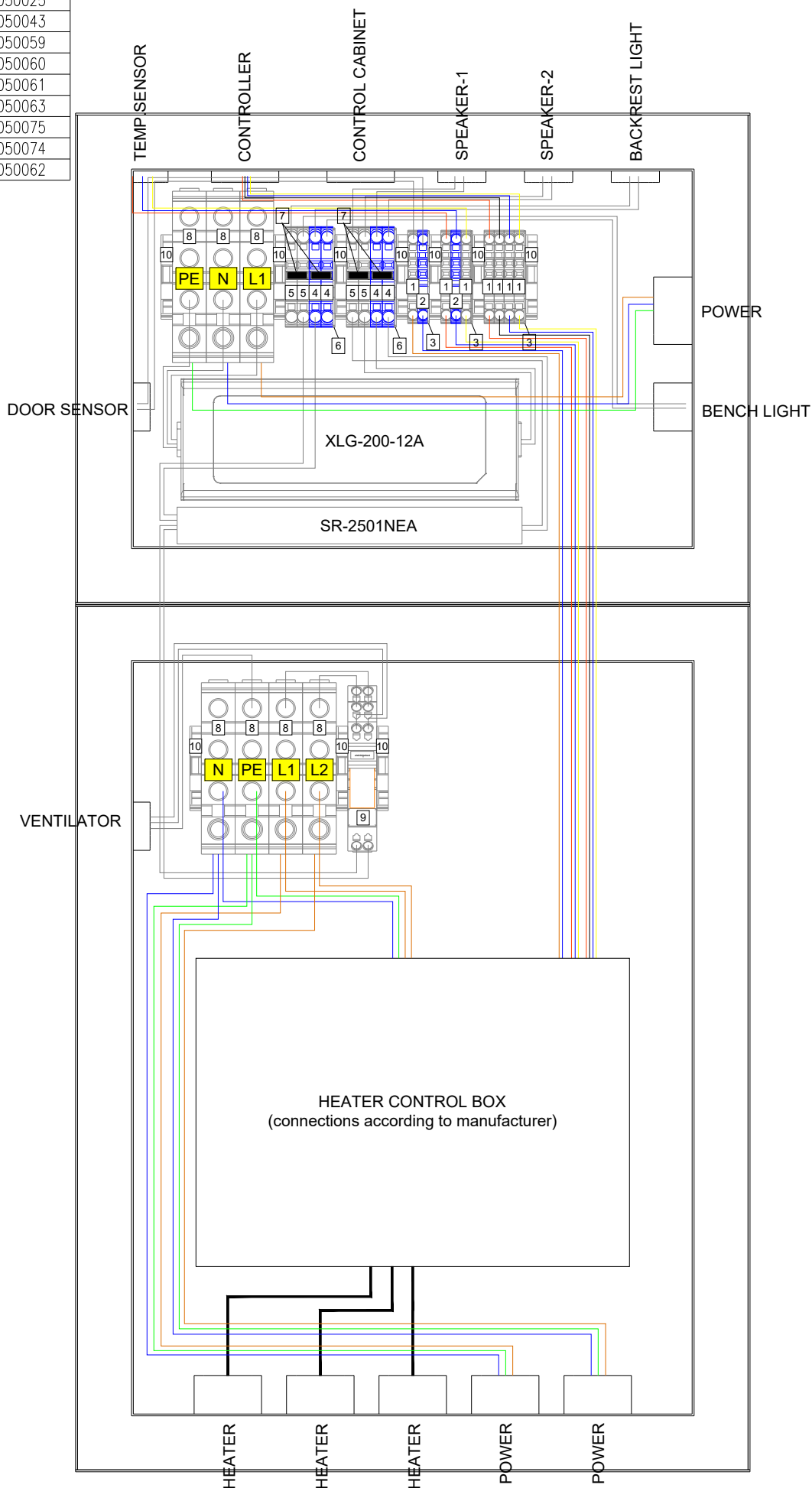

7. User guide

Using and connecting Bluetooth speakers

1. Make sure that Sauna is connected to external power
2. There is a red light on the speakers if they are not connected to any device
3. Turn on Bluetooth on your phone and search for available devices
4. "PROMARINE-BT65" should appear on the list
5. Connect your phone with it and speakers should make a sound to indicate a successful connection
6. Now there should be a blue light on the speakers and they are ready to transmit sound

Using remote controller

The remote is used to control Sauna's lights and extraction ventilator:

- Channel 1 – interior lights
- Channel 2 – ventilator



Interior lights (Channel 1) are dimmable when holding down ON or OFF button. Other Channels should be controlled by pressing ON/OFF button once, not holding them down.

8. Maintenance

General upkeep

- After each use, ensure that the sauna is properly ventilated. Turn on the ventilation system to help dry out any excessive moisture.
- Gently clean the surfaces of benches and cladding with a damp cloth to remove any sweat or dirt buildup. Do not use harsh chemicals or abrasives which could damage the wood.

Interior maintenance

- Treat interior wood surfaces with a wood preservative specially formulated for saunas to guard against rot and maintain its resistance to heat and moisture.
- Regularly remove the wooden floor grid and clean underneath. Sweep or vacuum any debris. Clean the wooden floor grid with a damp cloth and a gentle wood cleaner, avoid using excessive water.
- Routinely check corners and crevices for any signs of mold or mildew, treating them promptly if found.

Exterior care

- Clean the exterior cladding once year using special wood cleaner designed for outdoor use to prevent any mold or mildew formation.
- Check for any chipping or peeling on the exterior surface and reapply a protective finish if necessary.

General notes

- Never pour water over the heater when it is off.
- Do not leave combustible materials like towels inside the sauna after use.
- Ensure you read and follow all safety instructions provided by your sauna heater manufacturer regarding operation and maintenance activities.
- For any concerns regarding electrical systems, contact certified electricians for inspection and repair. Regularly conducting these maintenance steps will help prolong the life of your sauna and ensure a safe, enjoyable experience.
- Sauna door must be closed during heating to avoid over-heating!



SAUNA LIFE SAUNA LIMITED LIFETIME WARRANTY

Sauna Life extends this Limited Warranty solely to the original retail consumer purchaser of any Sauna Life sauna purchased from one of its authorized resellers.

LIMITED LIFETIME SAUNA WARRANTY

Sauna Life warrants that the Sauna Life sauna shall be free from defects in workmanship under normal conditions of use and service for the lifetime of the sauna for residential applications after delivery to the original retail purchaser. This warranty is limited to making good any factory assembled component which in the judgment of Sauna Life is deemed defective in workmanship. The warranty does not cover normal material wear, natural weathering of the lumber, or installation or delivery of components and applies only to the original retail purchaser.

WARRANTY PERFORMANCE

For any warranty service, Sauna Life reserves the right to choose, at its option, repair of the problem or a replacement of the defective part. Sauna Life reserves the right to substitute a part or component of equivalent value, either new or factory reconditioned, and any such repair or replacement shall assume as its warranty only the remaining portion of the warranty on the original product. In the event Sauna Life chooses to repair any malfunction or defect covered by this warranty, a return authorization will be issued, and the component will be returned prepaid freight to Sauna Life for repair of the defect. Sauna Life will then ship the component back the original retail purchaser upon completion of the repair. Prior to any return, contact Sauna Life at: Sauna Life, 511 Glenn Avenue, Wheeling, Illinois 60090, telephone number: (800) 957-2862, for packaging and shipping instructions and a return authorization number. In addition, Sauna Life will require photographs of any defect and reserves the right to inspect or designate an agent to inspect any part that is claimed to be defective and covered by this warranty. Labor charges and related expenses for removal, installation, or replacement of the sauna or its components are not covered under this warranty. Normal wear and tear, cosmetic issues or changes to individual pieces of lumber due to natural aging and weathering are not covered. Sauna heaters and added components are not covered by this warranty.













ACTS INVALIDATING WARRANTY







This warranty is void if the Sauna Life sauna has been subject to alteration, misuse or abuse, commercial use, or if any repairs on the sauna are attempted by anyone other than an authorized representative of Sauna Life. Alteration shall include, but is not limited to, deviation from the original assembly instructions, component change, or the addition of any non-approved device or heating system, which contributes to a component or unit failure, or unsafe operating system. Use of the sauna in an application for which it is not designed will void this warranty. This includes, but is not limited to, damage caused by operation above safe sauna operating temperatures, damage caused by added components, damage to the sauna's surface caused by harsh chemicals, damage caused by movement of the product, and damage caused by acts of God.





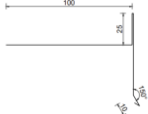
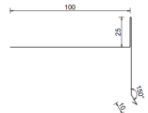
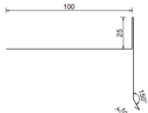
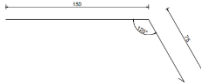
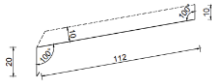
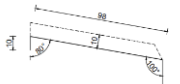





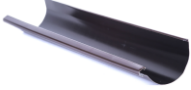

DISCLAIMERS







Except as expressly provided above, Sauna Life makes no other representation or warranty, express or implied, either in fact or operation of law, statute, or otherwise, and Sauna Life specifically disclaims any and all implied or statutory warranties, including warranties or merchantability and of fitness for a particular purpose. Sauna Life shall not be liable for loss of use of the Sauna Life sauna or other incidental or consequential costs, expenses, or damage, which may include but are not limited to, the removal of or reinstallation of a wall, deck or other fixture, water leakage, costs of shipping or packaging, applicable taxes, or the payment of any costs or expenses of disassembly, removal, or reinstallation of the product or any part. Your rights may vary from state to state. Under no circumstances shall Sauna Life or its representatives be held liable for injury to any person or damage to any property, however arising, even if caused by the Sauna Life Sauna or its representatives' negligence. No distributor, salesperson, dealer, retailer, or other representative of Sauna Life has the authority to alter or change these warranties either orally or in writing.

10. Spare parts

Order number	Part Name	Part Picture
7		
7		
-		
7		
7		
-		
#		
7		
k		
-		
°#)#o Q)		
k7 ok V-		
k7		

Order number	Part Name	Part Picture
u	V#	
Q)	ouk @ OS = u	
o		
h		
h		
h		
k		
)		
†		
k		
k		
k		
k		

\	h v	h h
k		
k		
k		
#		
"		
o		
o		
#	ou	
"		
"		
"		
o		
7		

\	h v	h h
·	· · · · ·	
·	· · · · ·	
·	u · · ·	
·) · · ·	
·	o · · ·	
·	o · · ·	
·) · · ·	

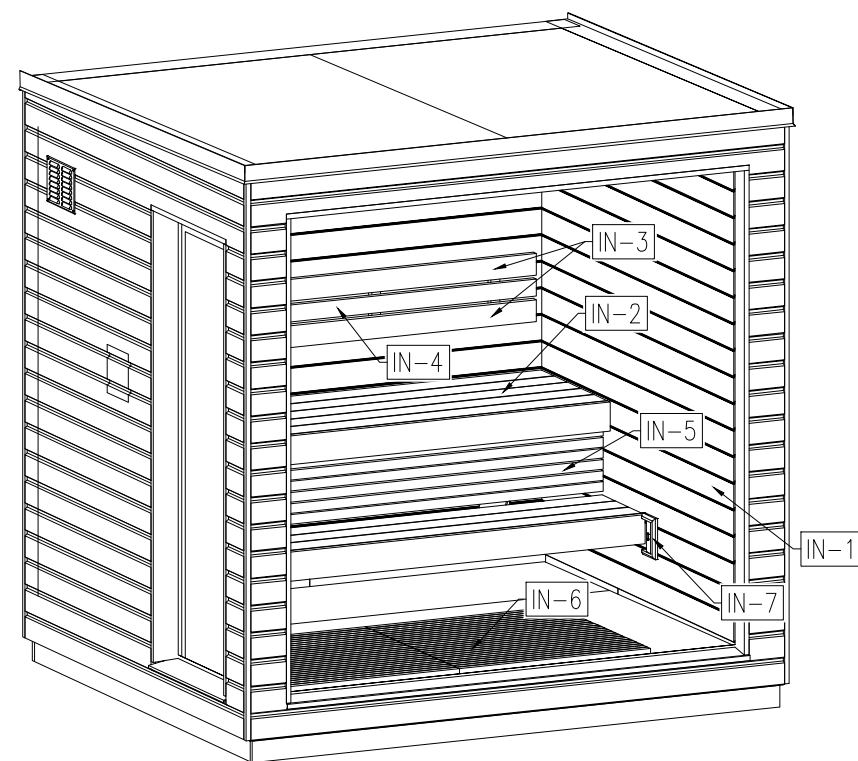
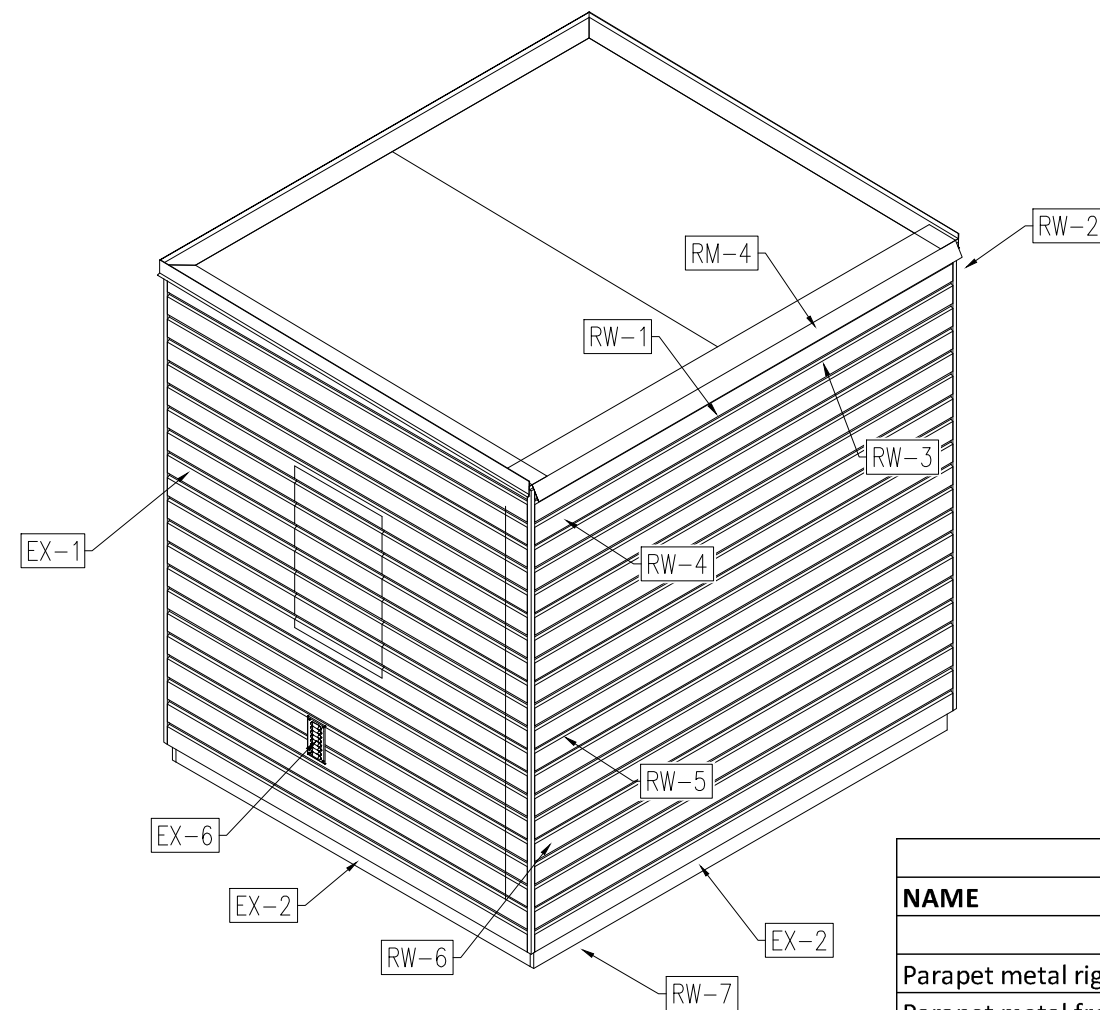
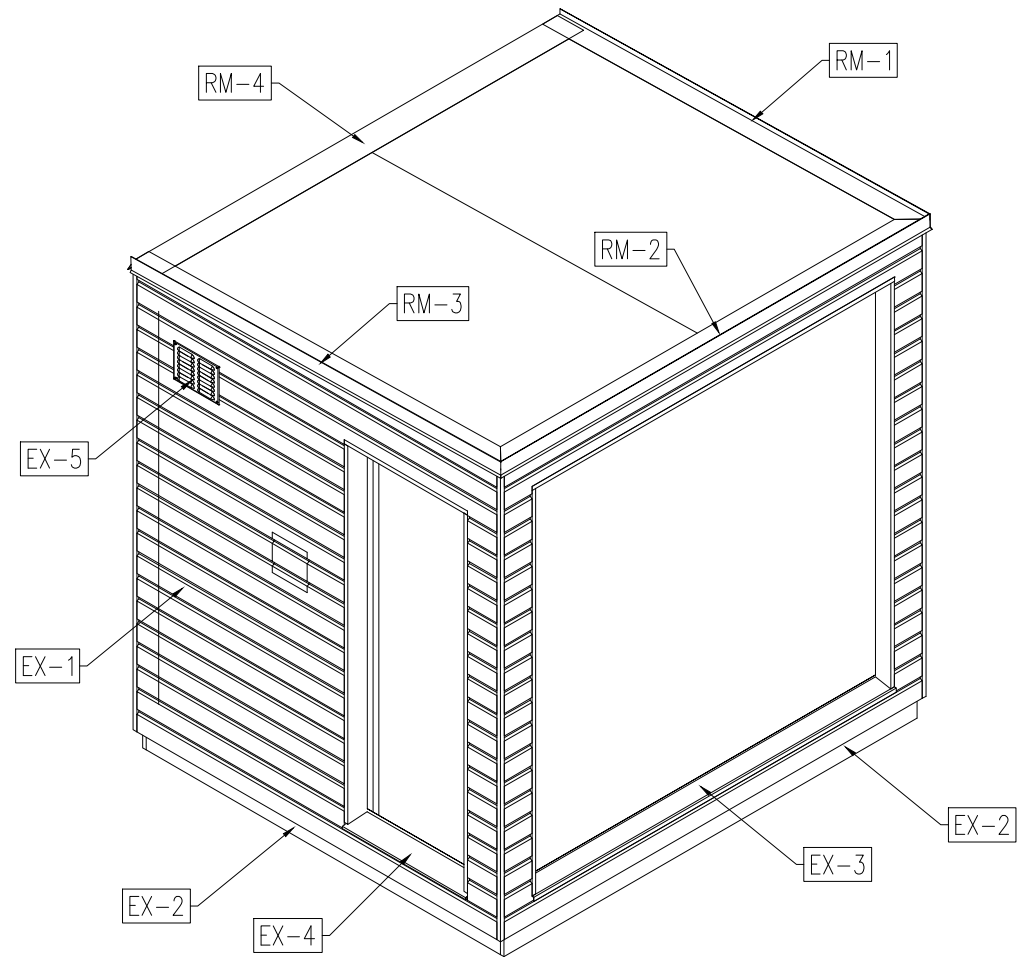

Classic		
NAME	SYMBOL	ORDER NR.
Roof		
Parapet metal right	RM-1	4030031
Parapet metal front	RM-2	4030024
Parapet metal left	RM-3	4030032
Roof drip metal	RM-4	4030021
Rainwater gutter	RW-1	4030033
Rainwater gutter end cap	RW-2	4030004
Rainwater gutter bracket	RW-3	4030003
Rainwater drop outlet	RW-4	4030002
Rainwater down pipe	RW-5	4030005
Rainwater down pipe bracket	RW-6	4030006
Rainwater outlet	RW-7	4030007
External		
Cladding board (1 pc 2,4m)	EX-1	7060019
Base board (1 pc 2,8m)	EX-2	7060004
Window metal	EX-3	4030028
Door metal	EX-4	4030022
Air outlet cover 260x190mm	EX-5	2020004
Air inlet cover 140x190mm	EX-6	2020011
Internal		
Cladding board STS3 15x120mm (1 pc 2,7m)	IN-1	7050005
Bench board 28x120mm (1 pc 2,7m)	IN-2	7070053
Backrest board 28x90mm (1 pc 2,4m)	IN-3	7070053
Backrest board 28x65mm (1 pc 2,4m)	IN-4	7070037
Skirt board 28x42mm (1 pc 2,4m)	IN-5	7070031
Floor grid board 28x28mm (1 pc 2,4m)	IN-6	7070025
Air inlet cover	IN-7	2020008

	PROJECT	G6		
	ADDRESS	-		
	CODE	-		
	DRAWING	Spare Parts		
	CONTRACT	-	SCALE	-
	DESIGNER	-	DATE	26.04.2024
	CHECK	-	PAGE	1/1
			FORMAT	A3



.com
info@saunalife.com

SKU - SL-MODELG6-L
REV: 2.0_09/2024